

**MÁQUINAS PARA TUBO / PIPING MACHINES / MACHINES POUR TUBE
ROHRBEARBEITUNGSMASCHINEN / MACCHINE PER TUBI / MÁQUINAS PARA
TUBO / МАШИНЫ ДЛЯ ОБРАБОТКИ ТРУБ**

15

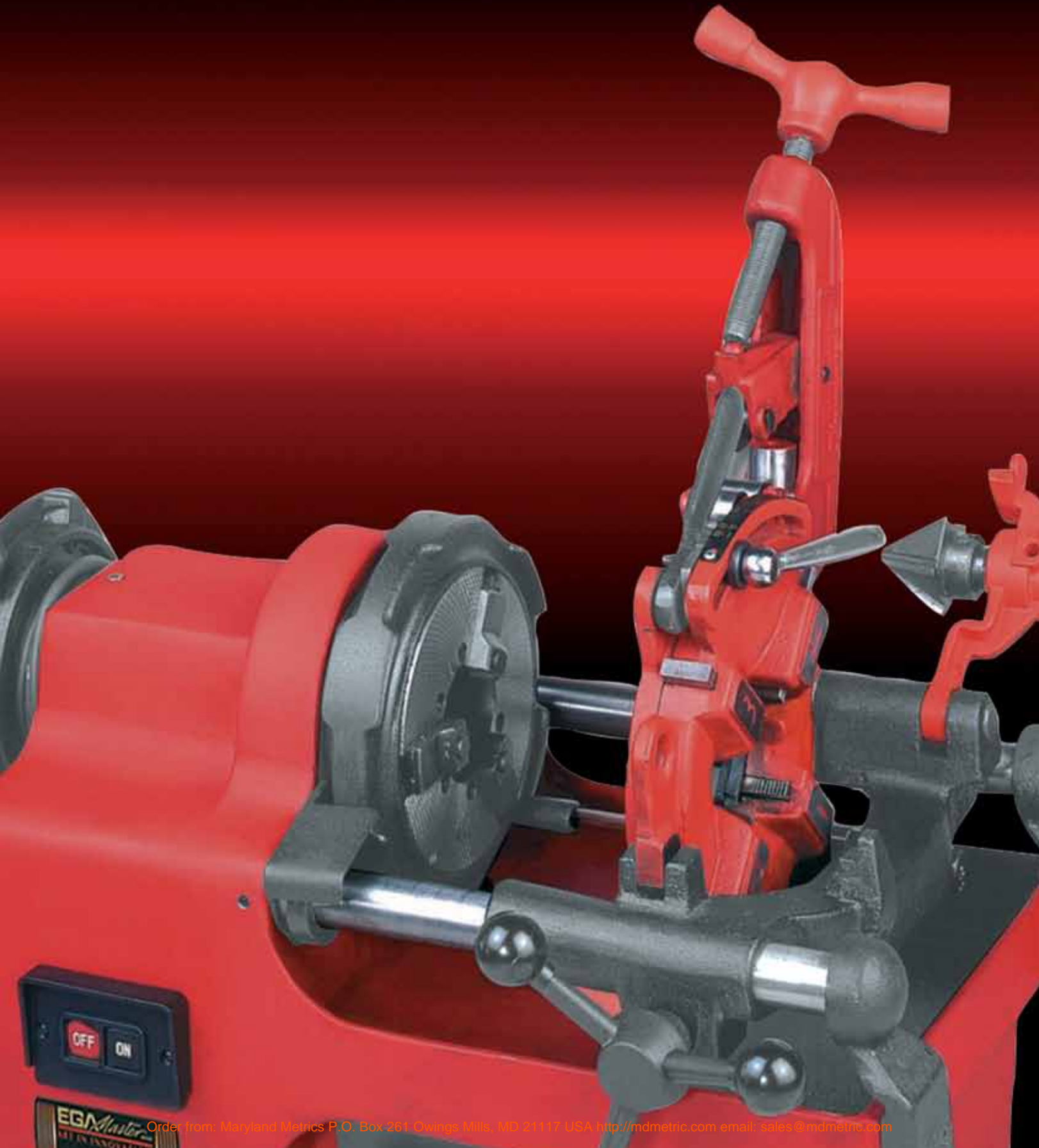

15

LA NUEVA MAQUINA "COMBI" PARA ROSCAR Y RANURAR TODO EN UNO THE NEW "COMBI" MACHINE FOR THREADING AND ROLL-GROOVING ALL-IN-ONE LA NOUVELLE MACHINE "COMBI" POUR FILETER ET RAINURER

1. Ranuradora hidráulica hasta 12", para ranurados de gran calidad en tubos de acero, cobre e inoxidable.
Hydraulic roll groover up to 12", for getting high quality grooves in steel, copper and stainless steel pipes.
Rainureuse hydraulique jusqu'à 12", pour un rainurage de grande qualité des tubes acier, cuivre et inox.
2. Especialmente diseñada para trabajos a domicilio por su formato compacto, robusto y fácil de transportar.
This machine is specially designed for job-site work due to its compact, strong and easy to transport format.
Spécialement conçue pour des travaux sur chantier, grâce à sa forme compacte, robuste et facile à transporter.
3. Disponible en 2 formatos, ranuradora o roscadora, ofrece la posibilidad de convertirla de una en otra con la simple adquisición del accesorio complementario, con lo que se dispondrá de ranuradora y roscadora en una sola máquina.
Available in 2 formats, roll groover or threading machine, offers the possibility to transform one into the other just by acquiring the required accessory, having at your disposal threading and roll-grooving functions in only one machine.
Disponible en deux versions, rainureuse ou filière, elle offre la possibilité de se convertir de l'une à l'autre, simplement par acquisition des accessoires complémentaires, ce qui vous permettra de posséder les deux en une.
4. El cambio de accesorios puede realizarse en pocos segundos, siendo así la operación de ranurado mucho más fácil.
Any accessory change-out can be accomplished in few seconds, making grooving operation much easier.
Les changements d'accessoires peuvent être réalisés en quelques secondes facilitant l'opération de rainurage.



RANUMATIC "COMBI"

Ranuradora hidráulica hasta 12", para ranurados de gran calidad en tubos de acero, cobre e inoxidable.

Hydraulic roll groover up to 12", for getting high quality grooves in steel, copper and stainless steel pipes.

Rainureuse hydraulique 12", pour un rainurage de grande qualité de tubes d'acier, de cuivre et d'inox.

ROSCAMATIC 3 "COMBI"

Máquina roscadora de tubos hasta 3" con motor de inducción, rosca tubo de manera eficiente y segura gracias a su innovador sistema de copia.

This threading machine can thread pipes up to 3" in a safe and efficient way due to its innovative copy system.

Filière jusqu'à 3" avec un moteur à induction, fait un filetage de qualité et sûr, grâce à son système innovateur de copie.



MÁQUINAS PARA TUBO / PIPING MACHINES / MACHINES POUR TUBE ROHRBEARBEITUNGSMASCHINEN / MACCHINE PER TUBI / MÁQUINAS PARA TUBO / МАШИНЫ ДЛЯ ОБРАБОТКИ ТРУБ

MÁQUINAS DE PENSADO RADIAL / RADIAL PRESS FITTING MACHINES /
MACHINES Á RACCORDS / RADIALPRESSE / MACCHINA PRESS FITTING RADIAL /
MAQUINAS DE PENSAR RADIAÍS / РАДИАЛЬНЫЕ ПРЕССПИСТОЛЕТЫ

PRESSMATIC PORTABLE CCA

La máquina de prensado radial Pressmatic Portable CCA es compacta, manejable, ligera y portátil. El sistema de portatenazas giratoria permite acceder fácilmente a los lugares de mas difícil acceso de forma cómoda e incluso a una sola mano. La rapidez de esta maquina se ve implementada por el sistema rápido de portamordazas, que permite un cambio eficiente y seguro de mordazas, así como por el sistema de retorno automático, que elimina tiempos muertos en las operaciones de prensado.

Su batería de 12V, 2.0 Ah le da una larga autonomía de uso en lugares sin red eléctrica, teniendo la posibilidad de ser empleado con conexión a la red para lugares con acceso de red (accesorio opcional).

Pressmatic CCA pressfitting machine is compact, handy, light and portable. The revolving press jaw carrying system enables jobs in difficult places, in a comfortable way even one handed. The press jaw carrying system as well as the automatic reverse system make it extremely quick and safe, saving time and making the job more efficient. The 12V, 2.0 Ah battery provides long autonomy in places without electricity. An optional accessory also provides an electric plug connection where electricity is available.

La machine á sertissage Radial Pressmatic Portable CCA est compacte, maniable, légère et portable. Le système de porte-machôires pivotant, permet d'accéder facilement dans des coins éxigüs et d'une seule main. La vitesse de cette machine est complétée para un système rapide de porte-machôires qui permet d'éviter les temps morts durant les opérations de sertissage. Sa batterie de 12 Volts, 2.0 Ah lui confère une grande autonomie dans les sites sans réseau électrique et peut être connectée au réseau (Accessoire en option).

Consulte en las siguientes páginas qué mordaza debe seleccionar dependiendo del sistema de accesorios de pensar que vaya a emplear.

Check the following pages to make the right choice of pressing jaws depending on the pres fitting system you may use.

Consultez dans les pages suivantes, la machoïre á sélectionner suivant le système d'accessoires á utiliser.



CE *G12



COD	V	CAP Ø	Kg	BAT.		
60196	230V 50-60Hz	10-76 (108)	4,5	●	●	●
60197	110V 50-60Hz					

ACCESORIOS / SPARE PARTS / RECHANGES / ERSATZTEILE / ACCESSORI / TOEBEHOREN / ACESSORIOS / ЗАПАСНЫЕ ЧАСТИ

COD	V
85000	Batería / Battery / Batterie 12V, 2.0 Ah



COD	V
85001	Cargador rápido / Quick charger 230V, 50 - 60Hz, 50W
85004	Chargeur rapide 110V, 50 -60Hz, 50W



COD	V
85002	Conexión / Connection / Connexion 230V
85003	110V



MÁQUINAS PARA TUBO / PIPING MACHINES / MACHINES POUR TUBE ROHRBEARBEITUNGSMASCHINEN / MACCHINE PER TUBI / MÁQUINAS PARA TUBO / МАШИНЫ ДЛЯ ОБРАБОТКИ ТРУБ

PRESSMATIC CCA

La máquina de prensado radial Pressmatic CCA es compacta, manejable y ligera. El sistema de portatenazas giratoria permite acceder fácilmente a los lugares de mas difícil acceso de forma cómoda e incluso a una sola mano. La rapidez de esta máquina se ve implementada por el sistema rápido de portamordazas, que permite un cambio eficiente y seguro de mordazas, así como por el sistema de retorno automático, que elimina tiempos muertos en las operaciones de prensado.

Pressmatic CCA pressfitting machine is compact, handy and light. The revolving press jaw carrying system enables jobs in difficult places, in a comfortable way even one handed. The press jaw carrying system as well as the automatic reverse system make it extremely quick and safe, saving time and making the job more efficient.

La machine de sertissage Radial Pressmatic CCA est compacte, maniable et légère. Le système porte-machoires pivotant permet d'accéder aisément dans les coins exigus de façon commode et d'une seule main. La rapidité de cette machine se voit confortée par un mécanisme rapide de porte-machoires, qui permet un changement efficient et sûr des machoires, ainsi que par le système de retour automatique qui élimine les temps morts durant les opérations de sertissage.

Consulte en las siguientes páginas qué mordaza debe seleccionar dependiendo del sistema de accesorios de prensar que vaya a emplear.

Check the following pages to make the right choice of pressing jaws depending on the pres fitting system you may use.

Consultez dans les pages suivantes, la machoire à sélectionner suivant le système d'accessoires à utiliser.



CE *G12



COD	V	CAP Ø	Kg.	W	
60194	230V 50-60Hz	10-76 (108)	5,0	450W	●
60195	110V 50-60Hz				

TENAZAS DE PRENSADO RADIAL / RADIAL PRESS FITTING PLIER / PINCES POUR RACCORDS PRESSZANGE / PINZA PER PRESS FITTING RADIAL / TURQUESES DE PRENSAR RADIAÍS / РУЧНОЕ ПРИСПОСОБЛЕНИЕ ДЛЯ ОБЖИМА

El prensador manual Masterpress permite prensar de forma rápida, cómoda y eficaz tubos de hasta 26mm de diámetro. Su reducido peso y sus mangos tubulares desmontables proporcionan un transporte rápido y confortable, para el que se ofrece una cómoda bolsa que permite además incluir 3 tenazas.

Utiliza las mismas tenazas de prensar que las máquinas Pressmatic (solo las indicadas con *, consultar pagina 284-286).

Masterpress hand pressfitting makes pressing tubes up to 26mm easy, quick and comfortable. Its light structure and removable handles provide convenient transportation. A handy bag is provided, which allows transporting 3 pressing tongues as well.

Masterpress hand pressfitting uses the same pressing tongues as Pressmatic machines (only the ones marked with *, please refer to page 284-286).

La pince à sertir manuelle Marterpress permet de sertir rapidement, aisément et efficacement des tubes jusqu'à un diamètre de 26 mm. Son poids réduit et ses manches tubulaires démontables permettent un transport rapide et commode à l'aide d'une poche dans laquelle on peut aussi incorporer 3 machoires.

La pince a les même machoires à sertir que les machines Pressmatic (uniquement celles indiquées avec *, consulter page 284-286)



COD	L mm	Kg.	
68450	655	2,8	●

**MÁQUINAS PARA TUBO / PIPING MACHINES / MACHINES POUR TUBE
ROHRBEARBEITUNGSMASCHINEN / MACCHINE PER TUBI / MÁQUINAS
PARA TUBO / МАШИНЫ ДЛЯ ОБРАБОТКИ ТРУБ**



**MORDAZAS PARA PRENSAR RADIAL / RADIAL PRESS FITTING TONGUES / MACHOÎRES
POUR RACCORDS / RADIALPRESSZANGEN / MORSA PER PRESS FITTING RADIAL /
MANDÍBULAS PARA PRENSAR RADIAÍS / НАСАДКИ**

Las mordazas de prensar EGA Master están fabricadas en acero especial forjado, con un endurecimiento especial que le confiere la máxima seguridad de prensado. Los contornos están diseñados específicamente para cada sistema de accesorios, habiendo sido mecanizados en centros de mecanizado de alta precisión, presentando así tolerancias inferiores a los realizados por microfundición, ofreciendo la máxima fiabilidad de prensado con cualquier sistema de accesorios de prensar. Se utilizan con las máquinas de prensar Pressmatic así como por la tenaza de prensar Masterpress, siendo también empleables por máquinas de otros fabricantes.

EGA Master pressing jaws are manufactured in special forging steel, being specially hardened. These features provide them with maximum working safety. Pressing contours are specifically designed for each pressing fitting system. They have been machined with high precision CNC machines, having much lower tolerances than microfusion, granting in this way maximum pressing reliability with any press fitting system. They are used with Pressmatic pressfitting machines, Masterpress pressing plier. They can also be used in other manufacturers machines.

Les machoires à sertir Egamaster sont fabriquées à partir d'un acier forgé spécial, avec une dureté qui lui confère une sécurité de sertissage maximum. Les contours sont conçus spécifiquement pour chaque système d'accessoires, étant usinés dans des ateliers de grande précision, donnant de cette façon des tolérances inférieures à celles acquises par microfusion, garantissant le maximum de fiabilité du sertissage avec tous les systèmes d'accessoires à sertir. Les machoires sont utilisées avec les machines à sertir Pressmatic, ainsi qu'avec la pince à sertir Matsterpress, pouvant être aussi utilisées avec les machines d'autres fabricants.

Consulte en las siguientes páginas qué mordaza debe seleccionar dependiendo del sistema de accesorios de prensar que vaya a emplear.

Check the following pages to make the right choice of pressing jaws depending on the pres fitting system you may use.

Consultez dans les pages suivantes, la machoire à sélectionner suivant le système d'accessoires à utiliser.



B		HA		RF		V	
CO		HRA		SA		VP	
F		KI		TH		VX	
G		M		U		WA	
H		MW		US			



15

**MÁQUINAS PARA TUBO / PIPING MACHINES / MACHINES POUR TUBE
ROHRBEARBEITUNGSMASCHINEN / MACCHINE PER TUBI / MÁQUINAS
PARA TUBO / МАШИНЫ ДЛЯ ОБРАБОТКИ ТРУБ**

System	COD	Type
AHSELL	68361	M 12
A-press	68363	M 15
Elgalvaniserant	68365	M 18
	68366	M 22
	68367	M 28
	68368	M 35
	68369	M 42 (4G)
	68370	M 54 (4G)
AHSELL	68421	V 12
A-press koppar	68423	V 15
	68425	V 18
	68426	V 22
	68427	V 28
	68428	V 35
	68429	V 42
	68430	V 54
AHSELL	68363	M 15
A-press rosfritt	68365	M 18
	68366	M 22
	68367	M 28
	68368	M 35
	68369	M 42 (4G)
	68370	M 54 (4G)
AIRBEL	68361	M 12
SERTINOX	68363	M 15
	68365	M 18
	68366	M 22
	68367	M 28
	68368	M 35
ANBO C-press	68361	M 12
	68363	M 15
	68365	M 18
	68366	M 22
	68367	M 28
	68368	M 35
	68369	M 42 (4G)
	68370	M 54 (4G)
APE Raccordi a pressare	68392	TH 14*
	68394	TH 16*
	68396	TH 18*
	68397	TH 20*
	68400	TH 26*
	68401	TH 32
Aquatis Xpress	68361	M 12
	68362	M 14 W
	68422	V 14
	68363	M 15
	68364	M 16 W
	68424	V 16
	68365	M 18
	68366	M 22
	68367	M 28
	68368	M 35
	68369	M 42 (4G)
	68370	M 54 (4G)
Armaturlonsson BALLOFIX PRES	68363	M 15
	68365	M 18
	68366	M 22
	68423	V 15
	68425	V 18
	68426	V 22
ASTM F 1807 (Fittings with Copper Crimp Ring for PEX tubing)	68418	US 3/8**
	68416	US 1/2**
	68417	US 3/4**
	68415	US 1**
	68420	US 1.1/4**
BAMPI BALPED BAMPI BALPEX	68392	TH 14*
	68394	TH 16*
	68396	TH 18*
	68397	TH 20*
	68400	TH 26*
	68401	TH 32
BARBI MULTIPLEX (Industrial Blansol)	68327	H 11.5*
	68329	H 14*
	68330	H 16*
	68331	H 17*
	68332	H 18*
	68333	H 20*
	68335	H 26*
	68336	H 32
	68337	H 40 (4G)
	68411	U 40
BEGETUBE/IVAR	68300	B 14*
	68301	B 16*
	68302	B 18*
	68303	B 20*
	68304	B 26
	68305	B 32
	68317	F 40
	68318	F 50
	68319	F 63 (S)
beulco armatur ab VSH-press	68361	M 12
	68363	M 15
	68365	M 18
	68366	M 22
	68367	M 28
	68368	M 35
	68369	M 42 (4G)
	68370	M 54 (4G)
BROEN BALLOFIX PRESS	68363	M 15
	68365	M 18
	68366	M 22
	68423	V 15
	68425	V 18
	68426	V 22
BUCCHI tech MP	68394	TH 16*
	68396	TH 18*
	68397	TH 20*
	68400	TH 26*
	68401	TH 32

System	COD	Type
chronimo-SANHA-NiroSan-Presssystem	68379	SA 12
	68380	SA 14
	68381	SA 15
	68382	SA 16
	68383	SA 18
	68384	SA 22
	68385	SA 28
	68386	SA 35
	68387	SA 42 (4G)
	68388	SA 54 (4G)
	68361	M 12
	68363	M 15
	68365	M 18
	68366	M 22
	68367	M 28
	68368	M 35
	68369	M 42 (4G)
	68370	M 54 (4G)
	68421	V 12
	68422	V 14
	68423	V 15
	68424	V 16
	68425	V 18
	68426	V 22
	68427	V 28
	68428	V 35
	68429	V 42
	68430	V 54
Climatek	68329	H 14*
ClimaTherm	68330	H 16*
	68333	H 20*
	68335	H 26*
	68336	H 32
	68337	H 40 (4G)
ClouSet Press	68394	TH 16*
	68396	TH 18*
	68397	TH 20*
CO.E.S Coesklima	68405	U 14*
	68406	U 16*
	68407	U 18*
	68408	U 20*
	68409	U 25*
	68410	U 32
	68411	U 40
	68412	U 50
	68413	U 63 (S)
	68414	U 75 (S)
Comap Sudopress Cu	68421	V 12
	68422	V 14
	68423	V 15
	68424	V 16
	68425	V 18
	68426	V 22
	68427	V 28
	68428	V 35
	68429	V 42
	68430	V 54
Comap Sudopress PEX (PER)	68307	CO-RFz 12*
	68308	CO-RFz 16*
	68309	CO-RFz 20*
	68310	CO-RFz 25*
Comap Multiskin Gas	68394	TH 16*
	68397	TH 20*
	68400	TH 26*
	68401	TH 32
Comap Sudopress Skin	68392	TH 14*
	68394	TH 16*
	68396	TH 18*
	68397	TH 20*
	68400	TH 26*
	68401	TH 32
	68402	TH 40
	68403	TH 50 (S)
	68404	TH 63 (S)
Comap Sudopress Skin Gas	68394	TH 16*
	68396	TH 18*
	68397	TH 20*
	68400	TH 26*
CosmoCONNECT	68312	F 16*
	68314	F 20*
	68315	F 26*
	68316	F 32
	68406	U 16*
	68408	U 20*
(NW26)	68409	U 25*
	68410	U 32
	68394	TH 16*
	68397	TH 20*
	68400	TH 26*
	68401	TH 32
Dalpex LaserMultiDalpex	68392	TH 14*
	68394	TH 16*
	68396	TH 18*
	68397	TH 20*
	68400	TH 26*
	68401	TH 32
	68402	TH 40
	68403	TH 50 (S)
Dalpex LaserMultiInox DiaNorm	68394	TH 16*
	68397	TH 20*
	68392	TH 14*
HKS SITEC Press	68394	TH 16*
	68396	TH 18*
	68397	TH 20*
	68400	TH 26*
	68401	TH 32
	68402	TH 40

System	COD	Type
DIWAflex systems	68394	TH 16*
	68397	TH 20*
	68400	TH 26*
	68401	TH 32
	68411	U 40
	68412	U 50
egeda Comisa	68394	TH 16*
	68397	TH 20*
	68400	TH 26*
	68401	TH 32
	68402	TH 40
egeda Baronio	68421	V 12
	68423	V 15
	68425	V 18
	68426	V 22
	68427	V 28
	68428	V 35
	68429	V 42
	68430	V 54
Elkhart XPRESS	68442	VUS 1/2"
	68444	VUS 3/4"
	68441	VUS 1"
	68440	VUS 1.1/4"
	68439	VUS 1.1/2"
	68443	VUS 2"
EMPUR PEXPRESS	68392	TH 14*
	68394	TH 16*
	68395	TH 17*
	68397	TH 20*
	68400	TH 26*
	68401	TH 32
eurotherm Multistrato Euro2000	68394	TH 16*
	68397	TH 20*
	68400	TH 26*
	68401	TH 32
EUROTUBI INOX PRESSFITTING SYSTEM	68363	M 15
	68365	M 18
	68366	M 22
	68367	M 28
	68368	M 35
	68369	M 42 (4G)
	68370	M 54 (4G)
FAR Rubinetterie PRESSFAR	68392	TH 14*
	68394	TH 16*
	68396	TH 18*
	68397	TH 20*
	68400	TH 26*
	68401	TH 32
	68402	TH 40
	68329	H 14*
	68330	H 16*
	68332	H 18*
	68333	H 20*
	68335	H 26*
	68336	H 32
	68337	H 40 (4G)
	68405	U 14*
	68406	U 16*
	68407	U 18*
	68408	U 20*
	68410	U 32
	68411	U 40
F.B.Q. BARONIO BQ press	68421	V 12
	68423	V 15
	68424	V 16
	68425	V 18
	68426	V 22
	68427	V 28
	68428	V 35
	68429	V 42
	68430	V 54
FIMISOL HAKAPRESS	68329	H 14*
	68330	H 16*
	68331	H 17*
	68332	H 18*
	68333	H 20*
	68335	H 26*
	68336	H 32
	68337	H 40 (4G)
	68411	U 40
Fränkische alpex-duo	68312	F 16*
	68313	F 18*
	68314	F 20*
	68315	F 26*
	68316	F 32
	68317	F 40
	68318	F 50
	68319	F 63 (S)
Fränkische alpex F50 PROF	68312	F 16*
	68314	F 20*
	68315	F 26*
	68316	F 32
	68406	U 16*
	68408	U 20*
(NW26)	68409	U 25*
	68410	U 32
	68394	TH 16*
	68397	TH 20*
	68400	TH 26*
	68401	TH 32
FRIATHERM Uni	68330	H 16*
	68333	H 20*
	68335	H 26*
	68336	H 32
	68337	H 40 (4G)
	68411	U 40

System	COD	Type
gabo Systemtechnik	68391	TH 12*
	68392	TH 14*
	68393	TH 15*
	68394	TH 16*
	68395	TH 17*
	68396	TH 18*
	68397	TH 20*
	68398	TH 25*
	68400	TH 26*
	68401	TH 32
	68402	TH 40
	68403	TH 50 (S)
	68404	TH 63 (S)
GAROS	68392	TH 14*
	68394	TH 16*
	68397	TH 20*
	68400	TH 26*
	68401	TH 32
	68402	TH 40
Geberit Mapress C-STAHLL, EDELSTAHL, EDELSTAHL Gas (15bis 35mm), KUPFER,	68361	M 12
	68363	M 15
	68365	M 18
	68366	M 22
	68367	M 28
	68368	M 35
KUPFER Gas (15 bis		

15

MÁQUINAS PARA TUBO / PIPING MACHINES / MACHINES POUR TUBE ROHRBEARBEITUNGSMASCHINEN / MACCHINE PER TUBI / MÁQUINAS PARA TUBO / МАШИНЫ ДЛЯ ОБРАБОТКИ ТРУБ



System	COD	Type
GS Warmensysteme System V	68423	V 15
	68425	V 18
	68426	V 22
	68427	V 28
	68428	V 35
HAGE DOMINOX	68363	M 15
	68365	M 18
	68366	M 22
	68367	M 28
	68368	M 35
	68369	M 42 (4G)
	68370	M 54 (4G)
HAGOS	68394	TH 16*
HAKA.GERODUR HAKAPRESS	68327	H 11.5*
	68329	H 14*
HALLTORP RORDELAR HR press Cu	68330	H 16*
	68331	H 17*
	68332	H 18*
	68333	H 20*
	68335	H 26*
	68336	H 32
	68337	H 40 (4G)
	68411	U 40
	68421	V 12
	68423	V 15
HALLTORP RORDELAR HR press 316 (Rostfritt), HR press FZ (Forzinkat)	68425	V 18
	68426	V 22
	68427	V 28
	68428	V 35
	68429	V 42
	68430	V 54
	68361	M 12
	68363	M 15
Harden 2000 Poly-Pex 2000	68365	M 18
	68366	M 22
	68367	M 28
	68368	M 35
	68369	M 42 (4G)
	68370	M 54 (4G)
	68392	TH 14*
Harden 2000 Plastic Press	68394	TH 16*
	68397	TH 20*
	68400	TH 26*
	68401	TH 32
	68402	TH 40
Henco	68403	TH 50 (S)
	68392	TH 14*
	68394	TH 16*
	68396	TH 18*
Herz Pipefix	68397	TH 20*
	68398	TH 25*
	68399	TH 28*
	68400	TH 32
	68401	TH 40
	68402	TH 50 (S)
	68403	TH 63 (S)
	68404	TH 63 (S)
	68406	U 16*
	68407	U 18*
HITEC Sistema Multistrato	68408	U 20*
	68409	U 25*
	68410	U 32
	68392	TH 14*
	68394	TH 16*
hs SYSTEM Heizung hs SYSTEM Sanitar	68396	TH 18*
	68397	TH 20*
	68400	TH 26*
	68401	TH 32
	68365	M 18
IBP>B<-press, IBP>B<-press Gas	68330	H 16*
	68332	H 18*
	68333	H 20*
	68335	H 26*
	68336	H 32
	68337	H 40 (4G)
	68421	V 12
	68422	V 14
	68423	V 15
	68424	V 16
IDROSISTEMI TA-PRESS	68425	V 18
	68426	V 22
	68427	V 28
	68428	V 35
	68429	V 42
	68430	V 54
	68394	TH 16*
	68397	TH 20*
	68400	TH 26*
	68401	TH 32

System	COD	Type
IMI	68361	M 12
	68362	M 14 W
	68422	V 14
	68363	M 15
	68364	M 16 W
	68424	V 16
	68365	M 18
	68366	M 22
	68367	M 28
	68368	M 35
IPAI IPANA-Press	68389	TH 10*
	68390	TH 11.6*
	68391	TH 12*
	68392	TH 14*
	68393	TH 15*
	68394	TH 16*
	68395	TH 17*
	68396	TH 18*
	68397	TH 20*
	68398	TH 25*
IPALPEX (Industrie du Plastique et Accessoires)	68400	TH 26*
	68401	TH 32
	68402	TH 40
	68403	TH 50 (S)
	68404	TH 63 (S)
	68392	TH 14*
	68394	TH 16*
	68396	TH 18*
	68397	TH 20*
	68400	TH 26*
IVAR IVAR-press	68401	TH 32
	68402	TH 40
	68403	TH 50 (S)
	68404	TH 63 (S)
	68300	B 14*
	68301	B 16*
	68302	B 18*
	68303	B 20*
	68304	B 26
	68305	B 32
Jager aquapress H	68317	F 40
	68318	F 50
	68319	F 63 (S)
	68329	H 14*
	68330	H 16*
	68331	H 17*
	68332	H 18*
	68333	H 20*
	68335	H 26*
	68336	H 32
Jaraflex- Presssystem	68337	H 40 (4G)
	68411	U 40
	68392	TH 14*
	68394	TH 16*
	68396	TH 18*
	68397	TH 20*
	68400	TH 26*
	68401	TH 32
	68402	TH 40
	68406	U 16*
JUPITER Heizsysteme	68408	U 20*
	68409	U 25*
	68410	U 32
	68411	U 40
	68403	TH 50 (S)
	68404	TH 63 (S)
	68406	U 16*
	68408	U 20*
	68409	U 25*
	68410	U 32
KAN-therm	68411	U 40
	68406	U 16*
	68408	U 20*
	68306	C 26
	68410	U 32
	68411	U 40
	68403	TH 50 (S)
	68404	TH 63 (S)
	68406	U 16*
	KELIT KELOX	68408
68409		U 25*
68410		U 32
68411		U 40
68412		U 50
68413		U 63 (S)
68414		U 75 (S)
68357		KI 16*
68358		KI 20*
68359		KI 25*
KOHLER inoxPRES	68363	M 15
	68365	M 18
	68366	M 22
	68367	M 28
	68368	M 35
Lagerstedt & Krantz LK B-press	68369	M 42 (4G)
	68370	M 54 (4G)
	68421	V 12
	68423	V 15
	68425	V 18
Lagerstedt & Krantz LK Universal	68426	V 22
	68427	V 28
	68428	V 35
	68429	V 42
	68430	V 54
LVAGRUND LAVA-PRESS	68394	TH 16*
	68397	TH 20*
	68399	TH 25 LK*
	68392	TH 14*
	68394	TH 16*
Mair Heiztechnik Gomafix M	68397	TH 20*
	68398	TH 25*
	68400	TH 26*
	68401	TH 32
	68402	TH 40
Mair Heiztechnik Gomafix CU/E	68327	H 11.5*
	68329	H 14*
	68330	H 16*
	68333	H 20*
	68335	H 26*
Mair Heiztechnik M-Press	68336	H 32
	68337	H 40 (4G)
	68392	TH 14*
	68394	TH 16*
	68396	TH 18*
Mapress Mark KG Polymark	68397	TH 20*
	68400	TH 26*
	68401	TH 32
	68394	TH 16*
	68397	TH 20*
M.a.s.ter System PRESSMASTER	68400	TH 25*
	68401	TH 32
	68402	TH 40
	68403	TH 50 (S)
	68404	TH 63 (S)
MAXITUB MAXIPRESS	68374	RF 12*
	68375	RF 16*
	68376	RF 20*
	68377	RF 25*
	68327	H 11.5*
MEGARO HAKAPRESS	68329	H 14*
	68330	H 16*
	68331	H 17*
	68332	H 18*
	68333	H 20*
MEGARO MEGAPRESS	68335	H 26*
	68336	H 32
	68337	H 40 (4G)
	68411	U 40
	68301	B 16*
MULTITHETRM- PRESSSYSTEM	68303	B 20*
	68304	B 26
	68305	B 32
	68317	F 40
	68318	F 50
multitubo systems	68319	F 63 (S)
	68394	TH 16*
	68396	TH 18*
	68397	TH 20*
	68400	TH 26*
NEUTHERM MEKUPRESS-HT	68401	TH 32
	68402	TH 40
	68406	U 16*
	68408	U 20*
	68409	U 25*
Nicoll MULTIPROJECT	68410	U 32
	68411	U 40
	68412	U 50
	68413	U 63 (S)
	68414	U 75 (S)
Niklaus Nico-Press	68330	H 16*
	68333	H 20*
	68335	H 26*
	68336	H 32
	68337	H 40 (4G)
N.T.M. winny-al	68411	U 40
	68394	TH 16*
	68396	TH 18*
	68397	TH 20*
	68400	TH 26*

System	COD	Type
Nupi MultiNupi	68405	U 14*
	68406	U 16*
	68407	U 18*
	68408	U 20*
	68306	C 26*
	68410	U 32
	68411	U 40
	68412	U 50
	68413	U 63 (S)
	68421	V 12
Nussbaum Cupress, Cupress G, Optipress	68423	V 15
	68425	V 18
	68426	V 22
	68427	V 28
	68428	V 35
Nussbaum Optiflex plus	68429	V 42
	68430	V 54
	68435	VP 16*
	68436	VP 20*
	68437	VP 25*
O.M.T. Heizungssystem	68438	VP 32
	68330	H 16*
	68332	H 18*
	68333	H 20*
	68335	H 26*
Oventrop Cofit P	68336	H 32
	68341	H 16 A*
	68344	H 20 A*
	68346	H 26 A*
	68347	H 32 A
Pavitherm MULTISTABIL	68348	H 40 A (4G)
	68392	TH 14*
	68394	TH 16*
	68396	TH 18*
	68397	TH 20*
PIPELIFE RADOPRESS	68400	TH 26*
	68401	TH 32
	68402	TH 40
	68394	TH 16*
	68396	TH 18*
PB TUB SAPRESS	68397	TH 20*
	68398	TH 26*
	68399	TH 32
	68400	TH 40
	68401	TH 50 (S)
POLYSAN Handelges m.b.H & Co KG (Krems-Osterreich) POLYSAN- Press-System	68402	TH 40
	68403	TH 50 (S)
	68404	TH 63 (S)
	68406	U 16*
	68407	U 18*
POLYSAN S.A. (Madrid-Espana) Sistema Rainbow	68408	U 20*
	68409	U 25*
	68410	U 32
	68411	U 40
	68412	U 50
Polytherm Polyfix Polyfix-MT	68413	U 63 (S)
	68338	H 10.5 A*
	68339	H 12 A*
	68340	H 14 A*
	68341	H 16 A*
Prandelli MULTYRAMA	68344	H 20 A*
	68346	H 26 A*
	68347	H 32 A
	68348	H 40 A (4G)
	68340	H 14 A*
PRASKI BAVARIA-press	68341	H 16 A*
	68343	H 18 A*
	68344	H 20 A*
	68346	H 26 A*
	68347	H 32 A
PURMO HKS Sitec Press	68411	U 40
	68412	U 50
	68389	TH 10*
	68394	TH 16*
	68395	TH 17*
remo	68397	TH 20*
	68400	TH 26*
	68401	TH 32
	68402	TH 40
	68329	H 14*
hs SYSTEM Heizung hs SYSTEM Sanitar	68330	H 16*
	68332	H 18*
	68333	H 20*
	68335	H 26*
	68336	H 32
IBP>B<-press, IBP>B<-press Gas	68337	H 40 (4G)
	68421	V 12
	68422	V 14
	68423	V 15
	68424	V 16
IDROSISTEMI TA-PRESS	68425	V 18
	68426	V 22
	68427	V 28
	68428	V 35
	68429	V 42

15

**MÁQUINAS PARA TUBO / PIPING MACHINES / MACHINES POUR TUBE
ROHRBEARBEITUNGSMASCHINEN / MACCHINE PER TUBI / MÁQUINAS
PARA TUBO / МАШИНЫ ДЛЯ ОБРАБОТКИ ТРУБ**

System	COD	Type
RIFENG U PRESS FITTING (F5)	68406 68407 68408 68409 68410 68411 68412 68413	U 16* U 18* U 20* U 25* U 32 U 40 U 50 U 63 (S)
RIFENG TH PRESS FITTING (F9)	68394 68397 68398 68400 68401	TH 16* TH 20* TH 25* TH 26* TH 32
RIQUIERA A SERTIR	68328 68330 68333 68334	H 12* H 16* H 20* H 25*
Rogapress	68392 68394 68395 68396 68397 68400 68401 68405 68406 68407 68408 68301 68302 68303 68304 68305 68329 68330 68331 68332 68333 68335 68336 68312 68314 68315 68316 68317 68318 68319	TH 14* TH 16* TH 17* TH 18* TH 20* TH 26* TH 32 U 14* U 16* U 18* U 20* B 16* B 18* B 20* B 26 B 32 H 14* H 16* H 17* H 18* H 20* H 26* H 32 F 16* F 20* F 26* F 32 F 40 F 50 F 63 (S)
Roth	68329 68330 68331 68333 68350 68351 68352 68353 68354	H 14* H 16* H 17* H 20* HR 14 A* HR 17 A* HR 20 A* HR 25 A HR 32 A
Rubinetterie Bresciane Bonomi TURBO INOX, TURBO STEEL	68361 68363 68365 68366 68367 68368 68369 68370	M 12 M 15 M 18 M 22 M 28 M 35 M 42 (4G) M 54 (4G)
Rubinetterie Bresciane Bonomi TURBO PRESS	68392 68394 68396 68397 68400 68401 68402 68403 68404	TH 14* TH 16* TH 18* TH 20* TH 26* TH 32 TH 40 TH 50 (S) TH 63 (S)
SANHA-Pressfittings, SANHA-NiroSan-Presssystem, SANHA-Pressfittings Gas SANHA-NiroSan-Presssystem Gas	68379 68380 68381 68382 68383 68384 68385 68386 68387 68388 68361 68363 68365 68366 68367 68368 68369 68370 68421 68422 68423 68424 68425 68426 68427 68428 68429 68430	SA 12 SA 14 SA 15 SA 16 SA 18 SA 22 SA 28 SA 35 SA 42 (4G) SA 54 (4G) M 12 M 15 M 18 M 22 M 28 M 35 M 42 (4G) M 54 (4G) V 12 V 14 V 15 V 16 V 18 V 22 V 28 V 35 V 42 V 54
Schlosser EUROPRESS-SYSTEM	68394 68397 68400 68401	TH 16* TH 20* TH 26* TH 32

System	COD	Type
SCHUTZ EHT rOpress	68392 68394 68397 68400 68401 68402	TH 14* TH 16* TH 20* TH 26* TH 32 TH 40
Schwer AQUApress	68361 68363 68365 68366 68367 68368 68369 68370	M 12 M 15 M 18 M 22 M 28 M 35 M 42 (4G) M 54 (4G)
Seppelfricke Distribuzione MTSD	68423 68426 68427 68428 68429	V 15 V 22 V 28 V 35 V 42
Seppelfricke Systemtechnik SST Delphi Press	68392 68394 68397 68400 68401 68402	TH 14* TH 16* TH 20* TH 26* TH 32 TH 40
SIKO TYPRO TYROTHERM	68392 68394 68396 68397 68400	TH 14* TH 16* TH 18* TH 20* TH 26*
Simplex VSH Dominox Edelstahl, VSH Press C-stahl, RYW Pressfittings Cu/Rg SiRoCon Cu/E	68361 68363 68365 68366 68367 68368 68369 68370	M 12 M 15 M 18 M 22 M 28 M 35 M 42 (4G) M 54 (4G)
Simplex SiRoCon Installationssystem H	68327 68330 68333 68335 68336	H 11.5* H 16* H 20* H 26* H 32
Simplex SiRoCon Installationssystem TH	68394 68397 68400 68401	TH 16* TH 20* TH 26* TH 32
SLOVARM PEX-THERM	68406 68408 68335 68410 68330 68333 68335 68336	U 16* U 20* H 26* U 32 H 16* H 20* H 26* H 32
SST-Rolltec Rosy	68340 68341 68344 68346 68347 68348	H 14 A* H 16 A* H 20 A* H 26 A* H 32 A H 40 A (4G)
SST-Rolltec Delphi-Press	68392 68394 68396 68397 68400 68401 68402	TH 14* TH 16* TH 18* TH 20* TH 26* TH 32 TH 40
STS Systemtechnik	68392 68394 68396 68397 68400 68401 68402	TH 14* TH 16* TH 18* TH 20* TH 26* TH 32 TH 40
System PREXTO	68361 68363 68365 68366	M 12 M 15 M 18 M 22
System WELCO-Flex	68340 68341 68342 68344 68346 68347 68348	H 14 A* H 16 A* H 17 A* H 20 A* H 26 A* H 32 A H 40 A (4G)
TECHNO TRADE/ Frankische	68312 68314 68315 68316 68317 68318	F 16* F 20* F 26* F 32 F 40 F 50
THERMAGAS Espace Express	68392 68394 68397 68400 68401 68402	TH 14* TH 16* TH 20* TH 26* TH 32 TH 40
THERMOLUTZ acular, rapid	68329 68330 68331	H 14* H 16* H 17*
THERMOVAL THERMOSMART	68392 68394 68396 68397 68400 68401	TH 14* TH 16* TH 18* TH 20* TH 26* TH 32

System	COD	Type
TIEMME COBRAPRESS	68392 68394 68397 68400 68401 68402 68403 68404	TH 14* TH 16* TH 20* TH 26* TH 32 TH 40 TH 50 (S) TH 63 (S)
TKM Fellingsbro TKMPRESS	68329 68330 68331 68332 68333 68335 68336 68337	H 14* H 16* H 17* H 18* H 20* H 26* H 32 H 40 (4G)
Ulrich VARIOFLEX-HAKAPRESS	68329 68330 68331 68332 68333 68335 68336 68337	H 14* H 16* H 17* H 18* H 20* H 26* H 32 H 40 (4G)
Uponor Unipipe Uponor Airpipe	68405 68406 68407 68408 68409 68410 68411 68412 68413 68414	U 14* U 16* U 18* U 20* U 25* U 32 U 40 U 50 U 63 (S) U 75 (S)
Valsir PEXAL	68329 68330 68333 68335 68411	H 14* H 16* H 20* H 26* U 40
Variotherm System H Variotherm System TH	68327 68330 68390 68394	H 11.5* H 16* TH 11.6* TH 16*
Vescal Metalplast	68406 68407 68408 68409 68410 68411 68412 68413	U 16* U 18* U 20* U 25* U 32 U 40 U 50 U 63 (S)
Viega- "Pexfit FOSTA" "PEXFIT PLUS"	68445 68446 68447	VX 12* VX 16* VX 20*
Viega-ProPress System (USA)	68442 68444 68441 68440 68439 68443	VUS 1/2* VUS 3/4* VUS 1* VUS 1.1/4* VUS 1.1/2* VUS 2*
Viega- "profitpress", "profitpress G" "profitpress THERM" "sanpress" "sanpress INOX" "sanpress INOX G"	68421 68431 68423 68432 68425 68426 68427 68428 68429 68430	V 12 VG 14 V 15 VG 16 V 18 V 22 V 28 V 35 V 42 V 54
Viega- "sanfix FOSTA" sanfix P" sanfix PLUS" "Viegatherm P"	68434 68435 68436 68437 68438	VP 14* VP 16* VP 20* VP 25* VP 32
Viessmann	68392 68394 68397 68400	TH 14* TH 16* TH 20* TH 26*
V.I. Trade ViTerm	68394 68396 68397 68400 68401	TH 16* TH 18* TH 20* TH 26* TH 32

System	COD	Type
VSH Flow Control	68363	M 15
Staalpress, Cu-Press, Cu-Press Gas, (15 - 28mm)	68365 68366 68367 68368	M 18 M 22 M 28 M 35
Inox-Press	68369 68370	M 42 (4G) M 54 (4G)
VSH Flow Control POLYPRESS	68394 68397 68400 68401 68402 68403	TH 16* TH 20* TH 26* TH 32 TH 40 TH 50 (S)
Watts MTR Art Press	68394 68397 68400 68401	TH 16* TH 20* TH 26* TH 32
Wavin Future K 1, Wavin Future K 2, Wavin Tigris, Wavin Tigris Alupex, Wavin Tigris Blue, Wavin Tigris PEX	68406 68407 68408 68409 68410 68411 68412	U 16* U 18* U 20* U 25* U 32 U 40 U 50
Wavin Tigris Press	68448 68449 68407	WA 12* WA 15* U 18*
WeeConPress	68363 68365 68366 68367 68368 68369 68370	M 15 M 18 M 22 M 28 M 35 M 42 (4G) M 54 (4G)
WEFA PLASTIC WEFATHERM-PRESS	68330 68333 68335 68336	H 16* H 20* H 26* H 32
WEM Winkler	68330 68392 68394 68396 68397 68400 68401 68402 68403	H 16* TH 14* TH 16* TH 18* TH 20* TH 26* TH 32 TH 40 TH 50 (S)
Wirsbo-Velta bioproduct P, Fusbodenheizung rapex multi	68340 68341 68342 68344 68345 68346 68347 68348	H 14 A* H 16 A* H 17 A* H 20 A* H 25 A* H 26 A* H 32 A H 40 A (4G)
WKS	68329 68330 68331 68332 68333 68335 68336 68337 68411	H 14* H 16* H 17* H 18* H 20* H 26* H 32 H 40 (4G) U 40
WOESTE "Yorkshire" RYW PRESS FITTINGS, RYW Gas PRESS FITTINGS, (15-35mm)	68361 68363 68365 68366 68367 68368 68369 68370	M 12 M 15 M 18 M 22 M 28 M 35 M 42 (4G) M 54 (4G)
ZEWOETHERM	68394 68395 68397 68400 68401 68402 68403 68404	TH 16* TH 17* TH 20* TH 26* TH 32 TH 40 TH 50 (S) TH 63 (S)

15

MÁQUINAS PARA TUBO / PIPING MACHINES / MACHINES POUR TUBE ROHRBEARBEITUNGSMASCHINEN / MACCHINE PER TUBI / MÁQUINAS PARA TUBO / МАШИНЫ ДЛЯ ОБРАБОТКИ ТРУБ

MÁQUINAS ROSCADORAS / PIPE THREADING MACHINES / FILIERES ELECTRIQUES /
GEWINDESCHNEIDMASCHINEN / FILETTATRICI ELETTRICA / TUBULAÇÃO QUE ROSQUEIA
MAQUINAS / РЕЗЬБОНАРЕЗНЫЕ МАШИНЫ

ROSCAMATIC - 1.1/2

CAP.	W	V	R.P.M.	Kg.
1/4-1.1/2"	1250	230/50-60Hz 110/50-60Hz	48	46

Motor Univ. / Moteur Univ. / Motore Univ.

Tubos / Pipes / Tubes: 1/4"-1.1/2"

Varilla / Rod / Boulon: 10mm-36mm



EQUIPO STANDARD / STANDARD EQUIPMENT / EQUIPEMENT STANDARD / STANDARDZUBEHÖR /
EQUIPAGGIAMENTO STANDARD / EQUIPAMENTO STANDARD / СТАНДАРТНЫЙ КОМПЛЕКТ

COD	Icon	V	Icon	Icon	Icon	Icon	Icon	Kg.
60140	BSPT	230/50-60Hz	81612	1/2-3/4", 1-1.1/2"	●	●	●	46
60141	NPT							
60142	BSPT	110/50-60Hz						
60143	NPT							

REPUESTOS / SPARE PARTS / RECHANGES / ERSATZTEILE / ACCESORI / ACESSORIOS / ЗАПАСНЫЕ ЧАСТИ

Icon	Icon	Icon	Icon	Icon	Icon	Icon	Icon	Icon
BSPT-NPT	BSW	METRIC	PG	Icon	Icon	Icon	HSS	5L
81612	81686	81617	81618	81614	81615	64104	64131	64002

BSPT		BSPT (HSS)		NPT		NPT (HSS)	
COD	Icon	COD	Icon	COD	Icon	COD	Icon
64108	1/4-3/8"	64111	1/4-3/8"	64114	1/4-3/8"	64117	1/4-3/8"
64109	1/2-3/4"	64112	1/2-3/4"	64115	1/2-3/4"	64118	1/2-3/4"
64110	1-1.1/2"	64113	1-1.1/2"	64116	1-1.1/2"	64119	1-1.1/2"

METRICO / METRIC (HSS)	
COD	Icon
64135	10
64136	12
64137	14-16
64138	18-22

METRICO / METRIC (HSS)	
COD	Icon
64139	24-27
64141	30-33
64142	36

BSW (HSS)	
COD	Icon
64120	3/8"
64121	1/2"
64122	5/8"
64123	3/4"
64124	7/8"
64125	1"
64126	1.1/8-1.1/4"
64127	1.1/2"

PG (HSS)	
COD	Icon
64146	PG9-PG16
64147	PG21-PG36



MÁQUINAS PARA TUBO / PIPING MACHINES / MACHINES POUR TUBE ROHRBEARBEITUNGSMASCHINEN / MACCHINE PER TUBI / MÁQUINAS PARA TUBO / МАШИНЫ ДЛЯ ОБРАБОТКИ ТРУБ

MÁQUINAS ROSCADORAS / PIPE THREADING MACHINES / FILIERES ELECTRIQUES /
GEWINDESCHNEIDMASCHINEN / FILETTATRICI ELETTRICA / TUBULAÇÃO QUE ROSQUEIA
MAQUINAS / РЕЗЬБОНАРЕЗНЫЕ МАШИНЫ

ROSCAMATIC - 2

CAP.	W	V	R.P.M.	Kg.
1/4"-2"	750	230/50-60Hz 110/50-60Hz	22	65

Motor Asíncrono / Condenser Motor / Moteur de Condensateur /
Kondensatormotor / Motore Asincrono / Motor Assincrono /
ИНДУКЦИОННЫЙ МОТОР

Tubos / Pipes / Tubes: 1/4"-2"

Varilla / Rod / Boulon: 10mm-52mm



EQUIPO STANDARD / STANDARD EQUIPMENT / EQUIPEMENT STANDARD / STANDARDZUBEHÖR /
EQUIPAGGIAMENTO STANDARD / EQUIPAMENTO STANDARD / СТАНДАРТНЫЙ КОМПЛЕКТ

COD		V		2 un		2L	Kg.
60150	BSPT	230/50-60Hz	81600	1/2-3/4" 1-2"	●	●	65
60151	NPT						
60152	BSPT	110/50-60Hz					
60153	NPT						

REPUESTOS / SPARE PARTS / RECHANGES / ERSATZTEILE / ACCESSORI / ACESSORIOS / ЗАПАСНЫЕ ЧАСТИ

BSTP-NPT-BSPP	BSW	METRIC	UNC	PG			HSS		6L	
81600	81619	81620	82918	81621	81601	81602	64104	64131	81603	64002

BSPT		BSPT (HSS)		NPT		NPT (HSS)	
COD		COD		COD		COD	
64148	1/4-3/8"	64151	1/4-3/8"	64154	1/4-3/8"	64157	1/4-3/8"
64149	1/2-3/4"	64152	1/2-3/4"	64155	1/2-3/4"	64158	1/2-3/4"
64150	1-2"	64153	1-2"	64156	1-2"	64159	1-2"

BSPP		BSPP (HSS)		METRICO / METRIC (HSS)	
COD		COD		COD	
64495	1/4-3/8"	64498	1/4-3/8"	64180	10
64496	1/2-3/4"	64499	1/2-3/4"	64181	12
64497	1-2"	64500	1-2"	64182	14-16
				64183	18-22
				64184	24-27
				64186	30-33
				64187	36
				64188	42-45
				64189	48-50-52

BSW (HSS)				PG (HSS)		UNC			
COD		COD		COD		COD		COD	
64160	3/8"	64165	1"	64200	PG9-PG16	64770	1/4"	64778	7/8"
64161	1/2"	64166	1.1/8-1.1/4"	64201	PG21-PG36	64771	5/16"	64779	1"
64162	5/8"	64167	1.1/2"	64202	PG42-PG-48	64772	3/8"	64780	1.1/8"
64163	3/4"	64168	1.5/8-1.3/4"			64773	7/16"	64781	1.1/4"
64164	7/8"	64169	1.7/8-2"			64774	1/2"	64782	1.3/8"
						64775	9/16"	64783	1.1/2"
						64776	5/8"	64784	1.3/4"
						64777	3/4"	64785	2"

15

MÁQUINAS PARA TUBO / PIPING MACHINES / MACHINES POUR TUBE ROHRBEARBEITUNGSMASCHINEN / MACCHINE PER TUBI / MÁQUINAS PARA TUBO / МАШИНЫ ДЛЯ ОБРАБОТКИ ТРУБ



MÁQUINAS ROSCADORAS / PIPE THREADING MACHINES / FILIERES ELECTRIQUES /
GEWINDESCHNEIDMASCHINEN / FILETTATRICI ELETTRICA / TUBULAÇÃO QUE ROSQUEIA
MAQUINAS / РЕЗЬБОНАРЕЗНЫЕ МАШИНЫ

ROSCAMATIC - 3

CAP.	W	V	R.P.M.	Kg.
1/2-3"	750	230/50-60Hz 110/50-60Hz	(1/2-2") = 25 (2.1/2-3") = 11	125

Motor Asíncrono / Condenser Motor / Moteur de Condensateur /
Kondensatormotor / Motore Asincrono / Motor Assíncrono /
ИНДУКЦИОННЫЙ МОТОР

Sistema de copiado de rosca / Notch profiling die head. Copy system / Entaille
profilant. Le système principal de copie de matrice / Kerbe, Profiliert
Schneidkopf inkl. / Sistema de filettatura a copiare / Sistema de copiaror de
rosca / УНИВЕРСАЛЬНАЯ РЕЗЬБОНАРЕЗНАЯ ГОЛОВА

Tubos / Pipes / Tubes: 1/2"-3"



EQUIPO STANDARD / STANDARD EQUIPMENT / EQUIPEMENT STANDARD / STANDARDZUBEHÖR /
EQUIPAGGIAMENTO STANDARD / EQUIPAMENTO STANDARD / СТАНДАРТНЫЙ КОМПЛЕКТ

COD	Icon	V	2 un	3 un	Icon	Icon	6L	Kg.
60160	BSPT	230/50-60Hz	1/2-2" 2.1/2-3"	1/2-3/4" 1-2" 2.1/2-3"	●	●	●	125
60161	NPT							
60162	BSPT	110/50-60Hz						
60163	NPT							

REPUESTOS / SPARE PARTS / RECHANGES / ERSATZTEILE / ACCESORI / ACESSORIOS / ЗАПАСНЫЕ ЧАСТИ

Icon	Icon	Icon	Icon	Icon	HSS	Icon	Icon
81604	81605	81606	81607	64104	64131	81603	64002

BSPT		BSPT (HSS)		NPT		NPT (HSS)	
COD	Icon	COD	Icon	COD	Icon	COD	Icon
64205	1/2-3/4"	64209	1/2-3/4"	64213	1/2-3/4"	64217	1/2-3/4"
64206	1-2"	64210	1-2"	64214	1-2"	64218	1-2"
64207	2.1/2-3"	64211	2.1/2-3"	64215	2.1/2-3"	64219	2.1/2-3"



*G12: GARANTIA 12 MESES / 12 MONTHS OF WARRANTY / 12 MOIS DE GARANTIE / 12 MONATEN GARANTIE / 12 MAANDEN GARANTIE / 12 MESI DI GARANZIA / 12 МЕСЯЦЕВ ГАРАНТИЯ

NATO Commercial and Government Entity (NCAGE) Code / Código (NCAGE) OTAN: 8552B



Order from: Maryland Metrics P.O. Box 261 Owings Mills, MD 21117 USA <http://mdmetric.com> email: sales@mdmetric.com

**MÁQUINAS PARA TUBO / PIPING MACHINES / MACHINES POUR TUBE
ROHRBEARBEITUNGSMASCHINEN / MACCHINE PER TUBI / MÁQUINAS
PARA TUBO / МАШИНЫ ДЛЯ ОБРАБОТКИ ТРУБ**

**MÁQUINAS ROSCADORAS / PIPE THREADING MACHINES / FILIERES ELECTRIQUES /
GEWINDESCHNEIDMASCHINEN / FILETTATRICI ELETTRICA / TUBULAÇÃO QUE ROSQUEIA
MAQUINAS / РЕЗЬБОНАРЕЗНЫЕ МАШИНЫ**

ROSCAMATIC - 3 "COMBI"

CAP.	W	V	R.P.M.	Kg.
1/2-3"	750	230/50-60Hz 110/50-60Hz	(1/2-2") = 25 (2.1/2-3") = 11	100

Motor Asíncrono / Condenser Motor / Moteur de Condensateur /
Kondensatormotor / Motore Asincrono / Motor Assíncrono /
ИНДУКЦИОННЫЙ МОТОР

Sistema de copiado de rosca / Notch profiling die head. Copy system / Entaille
profilant. Le système principal de copie de matrice / Kerbe, Profiliert
Schneidkopf inkl. / Sistema de filettatura a copiare / Sistema de copiador de
rosca / УНИВЕРСАЛЬНАЯ РЕЗЬБОНАРЕЗНАЯ ГОЛОВА



Tubos / Pipes / Tubes: 1/2"-3"

**EQUIPO STANDARD / STANDARD EQUIPMENT / EQUIPEMENT STANDARD / STANDARDZUBEHÖR /
EQUIPAGGIAMENTO STANDARD / EQUIPAMENTO STANDARD / СТАНДАРТНЫЙ КОМПЛЕКТ**

COD	Icon	V	2 un	3 un	Icon	Icon	Kg.
60164	BSPT	230/50-60Hz	1/2-2" 2.1/2-3"	1/2-3/4" 1-2" 2.1/2-3"	●	●	100
60165	NPT						
60166	BSPT	110/50-60Hz					
60167	NPT						

REPUESTOS / SPARE PARTS / RECHANGES / ERSATZTEILE / ACCESORI / ACESSORIOS / ЗАПАСНЫЕ ЧАСТИ

Icon	Icon	Icon	Icon	Icon	Icon	Icon	Icon
1/2-2	2.1/2-3				HSS		5L
81604	81605	81606	81607	64104	64131	81603	64002

BSPT		BSPT (HSS)		NPT		NPT (HSS)	
COD	Icon	COD	Icon	COD	Icon	COD	Icon
64205	1/2-3/4"	64209	1/2-3/4"	64213	1/2-3/4"	64217	1/2-3/4"
64206	1-2"	64210	1-2"	64214	1-2"	64218	1-2"
64207	2.1/2-3"	64211	2.1/2-3"	64215	2.1/2-3"	64219	2.1/2-3"

**RANURADORA HIDRÁULICA / HYDRAULIC ROLL GROOVER / RAINUREUSE HYDRAULIQUE / HYDRAULISCHE
ROLLNUTMASCHINE / SCANALATORE IDRAULICO / RANURADORA HIDRAULICA / ГИДРАВЛИЧЕСКИЙ
ЖЕЛОБОНАКАТЧИК**

COD	CAP	Kg.	Icon
60185	1.1/4-12"	23	1

Opcional / optional / optionnel



**ACEITERA / OILER / BURETTE À HUILE / ÖLKANISTER / OLIIATORI / ALMOTOLIA /
МАСЛЯНЫЙ НАСОС**

COD	CAP	Kg.	Icon
64130	5L	3,0	1



15

MÁQUINAS PARA TUBO / PIPING MACHINES / MACHINES POUR TUBE ROHRBEARBEITUNGSMASCHINEN / MACCHINE PER TUBI / MÁQUINAS PARA TUBO / МАШИНЫ ДЛЯ ОБРАБОТКИ ТРУБ

MÁQUINAS ROSCADORAS / PIPE THREADING MACHINES / FILIERES ELECTRIQUES /
GEWINDESCHNEIDMASCHINEN / FILETTATRICI ELETTRICA / TUBULAÇÃO QUE ROSQUEIA
MAQUINAS / РЕЗЬБОНАРЕЗНЫЕ МАШИНЫ

ROSCAMATIC - 4

CAP.	W	V	R.P.M.	Kg.
1/2-4"	750	230/50-60Hz 110/50-60Hz	(1/2-2") = 25 (2.1/2-4") = 11	150

Motor Asíncrono / Condenser Motor / Moteur de Condensateur /
Kondensatormotor / Motore Asíncrono / Motor Assíncrono /
ИНДУКЦИОННЫЙ МОТОР



Sistema de copiado de rosca / Notch profiling die head. Copy system / Entaille
profilant. Le système principal de copie de matrice / Kerbe, Profiliert
Schneidkopf inkl. / Sistema de filettatura a copiare / Sistema de copiador de
rosca / УНИВЕРСАЛЬНАЯ РЕЗЬБОНАРЕЗНАЯ ГОЛОВА

Tubos / Pipes / Tubes: 1/2"-4"

Varilla / Rod / Boulon: 10mm-52mm

EQUIPO STANDARD / STANDARD EQUIPMENT / EQUIPEMENT STANDARD / STANDARDZUBEHÖR /
EQUIPAGGIAMENTO STANDARD / EQUIPAMENTO STANDARD / СТАНДАРТНЫЙ КОМПЛЕКТ

COD	Icon	V	Icon	Icon	Icon	Icon	Icon	Kg.
60170	BSPT	230/50-60Hz	2 un	3 un	●	●	●	150
60171	NPT							
60172	BSPT	110/50-60Hz	2.1/2-4"	1/2-3/4"	1-2"	2.1/2-4"		
60173	NPT							

REPUESTOS / SPARE PARTS / RECHANGES / ERSATZTEILE / ACCESORI / ACESSORIOS / ЗАПАСНЫЕ ЧАСТИ

Icon	Icon	Icon	Icon	Icon	Icon	Icon	Icon	Icon	Icon	Icon	Icon	Icon
1/2-2	2.1/2-4	BSPP	BSW	METRIC	UNC	PG	HSS	5L	81608	81609	81687	81721
81616	82919	81795	81610	81611	64104	64131	81603	64002				

BSPT		BSPT (HSS)		NPT		NPT (HSS)	
COD	Icon	COD	Icon	COD	Icon	COD	Icon
64205	1/2-3/4"	64209	1/2-3/4"	64213	1/2-3/4"	64217	1/2-3/4"
64206	1-2"	64210	1-2"	64214	1-2"	64218	1-2"
64208	2.1/2-4"	64212	2.1/2-4"	64216	2.1/2-4"	64220	2.1/2-4"

BSPP		BSPP (HSS)		METRICO / METRIC (HSS)	
COD	Icon	COD	Icon	COD	Icon
64495	1/4-3/8"	64498	1/4-3/8"	64180	10
64496	1/2-3/4"	64499	1/2-3/4"	64181	12
64497	1-2"	64500	1-2"	64182	14-16
				64183	18-22
				64184	24-27
				64186	30-33
				64187	36
				64188	42-45
				64189	48-50-52

BSW (HSS)				PG (HSS)		UNC			
COD	Icon	COD	Icon	COD	Icon	COD	Icon	COD	Icon
64160	3/8"	64165	1"	64200	PG9-PG16	64770	1/4"	64778	7/8"
64161	1/2"	64166	1.1/8-1.1/4"	64201	PG21-PG36	64771	5/16"	64779	1"
64162	5/8"	64167	1.1/2"	64202	PG42-PG48	64772	3/8"	64780	1.1/8"
64163	3/4"	64168	1.5/8-1.3/4"			64773	7/16"	64781	1.1/4"
64164	7/8"	64169	1.7/8-2"			64774	1/2"	64782	1.3/8"
						64775	9/16"	64783	1.1/2"
						64776	5/8"	64784	1.3/4"
						64777	3/4"	64785	2"

*G12: GARANTIA 12 MESES / 12 MONTHS OF WARRANTY / 12 MOIS DE GARANTIE / 12 MONATEN GARANTIE / 12 MAANDEN GARANTIE / 12 MESI DI GARANZIA / 12 МЕСЯЦЕВ ГАРАНТИЯ

NATO Commercial and Government Entity (NCAGE) Code / Código (NCAGE) OTAN: 8552B



**MÁQUINAS PARA TUBO / PIPING MACHINES / MACHINES POUR TUBE
ROHRBEARBEITUNGSMASCHINEN / MACCHINE PER TUBI / MÁQUINAS
PARA TUBO / МАШИНЫ ДЛЯ ОБРАБОТКИ ТРУБ**

**MÁQUINAS ROSCADORAS / PIPE THREADING MACHINES / FILIERES ELECTRIQUES /
GEWINDESCHNEIDMASCHINEN / FILETTATRICI ELETTRICA / TUBULAÇÃO QUE ROSQUEIA
MAQUINAS / РЕЗЬБОНАРЕЗНЫЕ МАШИНЫ**

ROSCAMATIC - 6

CAP.	W	V	R.P.M.	Kg.
2.1/2-6"	1100	230/50-60Hz	(2.1/2-4") = 16	210
		110/50-60Hz	(5-6") = 6	

Motor Asíncrono / Condenser Motor / Moteur de Condensateur /
Kondensatormotor / Motore Asíncrono / Motor Assíncrono /
ИНДУКЦИОННЫЙ МОТОР

Sistema de copiado de rosca / Notch profiling die head. Copy system / Entaille
profilant. Le système principal de copie de matrice / Kerbe, Profiliert
Schneidkopf inkl. / Sistema de filettatura a copiare / Sistema de copiador de
rosca / УНИВЕРСАЛЬНАЯ РЕЗЬБОНАРЕЗНАЯ ГОЛОВА



Tubos / Pipes / Tubes: 2.1/2"-6"

**EQUIPO STANDARD / STANDARD EQUIPMENT / EQUIPEMENT STANDARD / STANDARDZUBEHÖR /
EQUIPAGGIAMENTO STANDARD / EQUIPAMENTO STANDARD / СТАНДАРТНЫЙ КОМПЛЕКТ**

COD	Icon	V	Icon	Icon	Icon	Icon	Icon	Kg.
60190	BSPT	230/50-60Hz	2 un	2 un	●	●	●	210
60191	NPT							
60192	BSPT	110/50-60Hz	2 un	●	●	●		
60193	NPT						5-6"	

REPUESTOS / SPARE PARTS / RECHANGES / ERSATZTEILE / ACCESORI / ACESSORIOS / ЗАПАСНЫЕ ЧАСТИ

Icon	Icon	Icon	Icon	Icon	Icon	Icon	Icon
2.1/2-4	5-6				HSS		5L
81622	81623	81624	81625	64271	64132	81603	64002

BSPT		BSPT (HSS)		NPT		NPT (HSS)	
COD	Icon	COD	Icon	COD	Icon	COD	Icon
64208	2.1/2-4"	64212	2.1/2-4"	64216	2.1/2-4"	64220	2.1/2-4"
64221	5-6"	64223	5-6"	64222	5-6"	64224	5-6"



MÁQUINAS PARA TUBO / PIPING MACHINES / MACHINES POUR TUBE ROHRBEARBEITUNGSMASCHINEN / MACCHINE PER TUBI / MÁQUINAS PARA TUBO / МАШИНЫ ДЛЯ ОБРАБОТКИ ТРУБ

ACCESORIOS / SPARE PARTS / RECHANGES / ZUBEHÖR / ACCESSORI /
ACESSORIOS / ЗАПАСНЫЕ ЧАСТИ

CARRO HIDRÁULICO / HYDRAULIC TROLLEY / CHARIOT HYDRAULIQUE / HYDRAULISCHER ARBEITSWAGEN /
CARRELLO IDRAULICO / CARRO HIDRAULICO / ГИДРАВЛИЧЕСКАЯ ТЕЛЕЖКА

COD	A-B	L min - max	CAP	Kg.	
60184	600-900	295-1020	500kg	125	1



CARRO MANUAL / HAND TROLLEY / CHARIOT MANUEL / HANDGESTELLTER ARBEITSWAGEN / CARRELLO
MANUALE / CARRO MANUAL / РУЧНАЯ ТЕЛЕЖКА

COD		Kg.	
60181	ROSCAMATIC-2	30	1
60180	ROSCAMATIC-3	28	
60182	ROSCAMATIC-4	28	
60183	ROSCAMATIC-6	30	

No válida para modelos "COMBI" / Not valid for "COMBI" models
Non valide pour les modèles "COMBI"



SOPORTE PARA TUBOS / PIPE BRACKET / SUPPORT PER TUBES / ROHRHALTEWINKEL / SUPPORTO PER TUBI /
SUPORTE PARA TUBOS / ПОДСТАВКА ДЛЯ ТРУБ

COD	L min - max	Kg.	
60179	750-1200	5,0	1



ACEITERA / OILER / BURETTE À HUILE / ÖLKANISTER / OLIATORI / ALMOTOLIA / МАСЛЯНЫЙ НАСОС

COD	CAP	Kg.	
64130	5L	4,0	1



ACEITE DE CORTE / CUTTING OIL / HUILE DE COUPE / GEWINDESCHNEIDÖL / OLIO DATAGLIO / OLEO DE CORTE /
РЕЗЬБОНАРЕЗНОЕ МАСЛО

COD	CAP	Kg.	
64006	2L	2,0	1
64002	5L	4,5	



**MÁQUINAS PARA TUBO / PIPING MACHINES / MACHINES POUR TUBE
ROHRBEARBEITUNGSMASCHINEN / MACCHINE PER TUBI / MÁQUINAS
PARA TUBO / МАШИНЫ ДЛЯ ОБРАБОТКИ ТРУБ**

**MÁQUINAS ROSCADORAS / PIPE THREADING MACHINES / FILIERES ELECTRIQUES /
GEWINDESCHNEIDMASCHINEN / FILETTATRICI ELETTRICA / TUBULAÇÃO QUE ROSQUEIA
MAQUINAS / РЕЗЬБОНАРЕЗНЫЕ МАШИНЫ**

MASTERMATIC - 1

CAP.	W	V	Kg.
1-1/4"	1150	230/50-60Hz	6,0
		110/50-60Hz	

CABEZAS DE TERRAJA: Especialmente diseñadas con una mayor longitud para un asentamiento más preciso de los peines proporcionando una mejor rosca y más suavidad en el trabajo.

THREADING HEADS: Specialty designed and enlarged heads providing more precise dies setting for smoother and better threading.

FILIERES: Les filières sont spécialement conçues pour fixer plus précisément les peignes. Il en résulte une plus grande qualité de filetage.

SCHNEIDKÖPFE: Spezial entwickelte Schneidköpfe für eine genauere Einstellung der Schneidbacken sowie ein besseres Gewinde.

TESTE: Fatti con una guida allungata per facilitare l'infilamento del tubo e la estrazione dalla testa. Coperchio di precisione meccanizzato per un'ottima guida dei pettini e sopra dimensionato per un'assorbimento corretto della forza di lavoro.

CABEÇAS DE TARRACHA: Especialmente desenhadas com uma maior longitude para um assentamento mais preciso dos caçonetes, proporcionando uma melhor rosca e mais suavidade no trabalho.

РЕЗЬБОНАРЕЗНЫЕ ГОЛОВКИ: СПЕЦИАЛЬНО РАЗРАБОТАНЫ ДЛЯ ВЫПОЛНЕНИЯ БОЛЕЕ МЯГКОЙ НАРЕЗКИ



						230V		110V		
1/4"	3/8"	1/2"	3/4"	1"	1.1/4"	COD BSPT	COD NPT	COD BSPT	COD NPT	Kg.
-	-	●	●	●	●	69082	69087	69092	69097	13
-	●	●	●	●	●	69083	69088	69093	69098	14
●	●	●	●	●	●	69084	69089	69094	69099	15

230V	110V	50000	81530	64001
60130	60131	50000	81530	64001

ACEITERA / OILER / BURETTE À HUILE / ÖLKANISTER / OLIIATORI / ALMOTOLIA / МАСЛЯНЫЙ НАСОС

COD	CAP	Kg.	
64130	5L	4,0	1



15

**MÁQUINAS PARA TUBO / PIPING MACHINES / MACHINES POUR TUBE
ROHRBEARBEITUNGSMASCHINEN / MACCHINE PER TUBI / MÁQUINAS
PARA TUBO / МАШИНЫ ДЛЯ ОБРАБОТКИ ТРУБ**



**MÁQUINAS ROSCADORAS / PIPE THREADING MACHINES / FILIERES ELECTRIQUES /
GEWINDESCHNEIDMASCHINEN / FILETTATRICI ELETTRICA / TUBULAÇÃO QUE ROSQUEIA
MAQUINAS / РЕЗЬБОНАРЕЗНЫЕ МАШИНЫ**

MASTERMATIC - 2

CAP.	W	V	Kg.
2"	1350	230/50-60Hz 110/50-60Hz	8,0

CABEZAS DE TERRAJA: Especialmente diseñadas con una mayor longitud para un asentamiento más preciso de los peines proporcionando una mejor rosca y más suavidad en el trabajo.

THREADING HEADS: Specialty designed and enlarged heads providing more precise dies setting for smoother and better threading.

FILIERES: Les filières sont spécialement conçue pour fixer plus précisément les peignes. Il en résulte une plus grande qualité de filetage.

SCHNEIDKÖPFE: Spezial entwickelte Schneidköpfe für eine genauere Einstellung der Schneidbacken sowie ein besseres Gewinde.

TESTE: Fatti con una guida allungata per facilitare l'infilamento del tubo e la estrazione dalla testa. Coperchio di precisione meccanizzato per un'ottima guida nei pettini e sopra-dimensionato per un'assorbimento corretto della forza di lavoro.

CABEÇAS DE TARRACHA: Especialmente desenhadas com uma maior longitude para um assentamento mais preciso dos çaconetes, proporcionando uma melhor rosca e mais suavidade no trabalho.

РЕЗЬБОНАРЕЗНЫЕ ГОЛОВКИ: СПЕЦИАЛЬНО РАЗРАБОТАНЫ ДЛЯ ВЫПОЛНЕНИЯ БОЛЕЕ МЯГКОЙ НАРЕЗКИ



									230V		110V		
1/4"	3/8"	1/2"	3/4"	1"	1.1/4"	1.1/2"	2"		COD BSPT	COD NPT	COD BSPT	COD NPT	Kg.
-	-	●	●	●	●	●	●	●	69114	69121	69174	69181	13
-	●	●	●	●	●	●	●	●	69115	69122	69175	69182	14
●	●	●	●	●	●	●	●	●	69116	69123	69176	69183	15

230V	110V				
60148	60149	51050	85930	85931	64001

ACEITERA / OILER / BURETTE A HUILE / ÖLKANISTER / OLIIATORI / ALMOTOLIA / МАСЛЯНЫЙ НАСОС

COD	CAP	Kg.	
64130	5L	4,0	1



**MÁQUINAS PARA TUBO / PIPING MACHINES / MACHINES POUR TUBE
ROHRBEARBEITUNGSMASCHINEN / MACCHINE PER TUBI / MÁQUINAS
PARA TUBO / МАШИНЫ ДЛЯ ОБРАБОТКИ ТРУБ**

**RANURADORA HIDRÁULICA / HYDRAULIC ROLL GROOVER / RAINUREUSE HYDRAULIQUE /
HYDRAULISCHE ROLLNUTMASCHINE / SCANALATORE IDRAULICO / RANHURADORA
HIDRÁULICA / ГИДРАВЛИЧЕСКИЙ ЖЕЛОБОНАКАТЧИК**

RANUMATIC "COMBI"

CAP.	W	V	R.P.M.	Kg.
1.1/4"-12"	750	230/50-60Hz 110/50-60Hz	(1.1/4-6") = 25 (8-12") = 11	110

Motor Asíncrono / Condenser Motor / Moteur de Condensateur /
Kondensatormotor / Motore Asíncrono / Motor Assíncrono /
ИНДУКЦИОННЫЙ МОТОР



Tubos / Pipes / Tubes: 1.1/4"-12"

CAPACIDAD DE RANURADO DE TUBOS / PIPE GROOVING CAPACITY / DIAMÉTRE MAXIMUM DE RAINURAGE /
KAPAZITÄT DER ROHRNUTEN / CAPACITÀ DI SCANALATURA DEL TUBO / CAPACIDADE DE RANHURAGEM DE
TUBO / ПАРАМЕТРЫ ЖЕЛОБОНАКАТКИ

	1.1/4"	1.1/2"	2"	2.1/2"	3"	4"	6"	8"	10"	12"
SCHEDULE 10	2,8	2,8	2,8	3,0	3,0	3,4	3,4	3,8	4,2	4,6
SCHEDULE 40	3,6	3,4	3,9	5,2	5,5	6,0	7,1	8,2	-	-
DIN 2440	3,25	3,25	3,65	3,65	4,03	4,5	4,85	-	-	-

INOX - hasta 4,8 mm
up to 4,8 mm





EQUIPO STANDARD / STANDARD EQUIPMENT / EQUIPEMENT STANDARD / STANDARDZUBEHÖR /
EQUIPAGGIAMENTO STANDARD / EQUIPAMENTO STANDARD / СТАНДАРТНЫЙ КОМПЛЕКТ

COD	V				Kg.
60168	230	1.1/4-6"			110
60169	110	8-12"			

REPUESTOS / SPARE PARTS / RECHANGES / ERSATZTEILE / ACCESSORI / ACESSORIOS / ЗАПАСНЫЕ ЧАСТИ

			
60174	60175	81603	60176

CARRO DE ROSCAR 3" / THREADING CARRIAGE / CHARRIOT DE FILETAGE 3" / GEWINDESCHNEIDHALTER /
BANCO MOTORIZZATI / CARRO DE ROSCAR 3" / РЕЗЬБОНАРЕЗНАЯ КАРЕТКА

COD		 2 un	 3 un			Kg.
60186	BSPT	1/2-2"	1/2-3/4"			100
60189	NPT	2.1/2-3"	1-1/2", 2.1/2-3"			

Opcional / optional / optionnel



CABALLETE / PIPE SUPPORT / SUPPORT DE TUBE / ROHRHALTEWINKEL / CAVALLETTO PER TUBI / CAVALETE
PARA TUBO / ПОДСТАВКА ДЛЯ ТРУБ

COD	Kg.	
60176	7,5	1





15

**MÁQUINAS PARA TUBO / PIPING MACHINES / MACHINES POUR TUBE
ROHRBEARBEITUNGSMASCHINEN / MACCHINE PER TUBI / MÁQUINAS
PARA TUBO / МАШИНЫ ДЛЯ ОБРАБОТКИ ТРУБ**





SIERRA DE CINTA / ELECTRIC BANDSAW / SCIE À RUBAN / BANDSÄGE / SEGA DI NASTRO / SERRA DE FITA /
ЛЕНТОЧНАЯ ПИЛА

MULTIFUNCIÓN / MULTIFUNCTION / MULTI-FONCTIONS / MULTIFUNKTION /
MULTIFUNZIONE / MULTIFUNÇÕES / МНОГОФУНКЦИОНАЛЬНАЯ

COD	CAP	CAP	W	V		Kg.
60128	115	120x115	320	230	1356x13x0,65	21
60129				110		
COD						
64311			1356x13x0,65 - 14			
64312			1356x13x0,65 - 18			



CABEZAL PORTÁTIL / PORTABLE HEAD / TÊTE PORTABLE
TRAGBARER KOPF / TESTA PORTATILE / CABEÇA PORTÁTIL
РУЧНАЯ ЛЕНТОЧНАЯ ПИЛА

COD	CAP	CAP	W	V		Kg.
60220	115	120x115	320	230	1356x13x0,65	10
60221				110		
COD						
64311			1356x13x0,65 - 14			
64312			1356x13x0,65 - 18			



SIERRA ELECTROPORTÁTIL / RECIPROCATING SAW / SCIE SABRE UNIVERSELLE / TRAGBARE ELEKTROSÄGE /
SEGHETO ELETRICO / SERRA ELECTRO PORTATIL / САБЕЛЬНАЯ ПИЛА

COD	CAP metal / wood	W	R.P.M.	V	Kg.
60216	90/115	750	2500	230	5,0
60217				110	
COD					
64411 (metal)		152x0,9 - 25,5			
64412 (wood)		152x1,2 - 10,5			



15

MÁQUINAS PARA TUBO / PIPING MACHINES / MACHINES POUR TUBE ROHRBEARBEITUNGSMASCHINEN / MACCHINE PER TUBI / MÁQUINAS PARA TUBO / МАШИНЫ ДЛЯ ОБРАБОТКИ ТРУБ

**CORTATUBOS PROPULSADO / POWER PIPE CUTTER / COUPE TUBE ELECTRIQUE /
ROHRTRENNGERÄT / TAGLIATUBI ALIMENTATO / CORTA TUBOS ELECTRO-HIDRÁULICO /
ТРУБОРЕЗ С ЭЛЕКТРОПРИВОДОМ**

KIT CORTAMATIC - 12

SET CON MASTERMATIC-2 / SET INCLUDING MASTERMATIC-2 / SET INCLUS MASTERMATIC-2 / SET INCLUSIVE
MASTERMATIC-2 / ASSORTIMENTO CON MASTERMATIC 2 / CONJUNTO COM MASTERMATIC 2 /
НАБОР С MASTERMATIC-2

COD	V	CAP	Kg.
60000	230	2.1/2-12"	75
60001	110		



CORTAMATIC - 12

COD	CAP	Kg.
60002	2.1/2-12"	65



Especificaciones técnicas / Technical specification / Détails techniques

Poderoso cilindro hidráulico de 10 toneladas / Powerful 10-ton hydraulic cylinder /
Cylindre hydraulique puissant de 10 tonnes

Cortes perfectos en escuadra, sin chispas ni polvo / Perfect square cuts, without dust
or sparks / Coupes parfaites à angles droits, sans étincelles ni poussière

Incluidos 2 soportes para tubo / 2 pipe stands included / 2 supports pour tube inclus



CAPACIDAD DE CORTE DE TUBOS (ESPEJOR MM) / PIPE CUTTING CAPACITY (THICKNESS MM) / CAPACITÉ DE
COUPE-TUBE (ÉPAISSEUR EN MM) / SCHNITTKAPAZITÄT FÜR ROHRE (DICHTEN IN MM) / CAPACITÀ DI TAGLIO
DEL TUBO (SPESSORE MM) / CAPACIDAD DE CORTE DE TUBOS (ESPESSURA EM MM) /
РАЗМЕР ТРУБЫ (ТОЛЩИНА В ММ)

	2.1/2"	3"	4"	5"	6"	8"	10"	12"
SCHEDULE 10	3,05	3,05	3	3,4	3,4	4,78	4,19	4,57
SCHEDULE 40	5,16	5,49	6,02	6,55	7,11	8,18	-	-
DIN 2440	3,65	4,05	4,5	4,85	4,85	-	-	-

REPUESTOS / SPARE PARTS / RECHANGES / ERSATZTEILE / ACCESSORI / ACESSORIOS / ЗАПАСНЫЕ ЧАСТИ



60003



60017



60018

15

MÁQUINAS PARA TUBO / PIPING MACHINES / MACHINES POUR TUBE ROHRBEARBEITUNGSMASCHINEN / MACCHINE PER TUBI / MÁQUINAS PARA TUBO / МАШИНЫ ДЛЯ ОБРАБОТКИ ТРУБ

CONGELADOR DE TUBO / PIPE FREEZER / CONGÉLATEUR DE TUBE /
ROHR-EINFRIERGERÄT / CONGELATUBI / CONGELADOR DA TUBULAÇÃO / ЗАМОРОЗКА
MASTERFREEZE

Ø		t.	Ø		t.
1/8"	(Fe)	1min	1"	(Fe)	7min
10-12mm	(Cu)		35mm	(Cu)	10min
1/4"	(Fe)	2min	1.1/4"	(Fe)	11min
14-15mm	(Cu)		42mm	(Cu)	14min
3/8"	(Fe)	3min	1.1/2"	(Fe)	16min
16-18mm	(Cu)		54mm	(Cu)	24min
1/2"	(Fe)	5min	2"	(Fe)	29min
22mm	(Cu)		60mm	(Cu)	
3/4"	(Fe)	7min			
28mm	(Cu)				



EQUIPO STANDARD / STANDARD EQUIPMENT / EQUIPEMENT STANDARD / STANDARDZUBEHÖR /
EQUIPAGGIAMENTO STANDARD / EQUIPAMENTO STANDARD / СТАНДАРТНЫЙ КОМПЛЕКТ

COD		CAP (Cu)	CAP (Fe)	Kg.	
60275	EUR.	10-60mm	1/8"-2"	5,0	1
60276	USA	1/4"-2"			

REPUESTOS / SPARE PARTS / RECHANGES / ERSATZTEILE / ACCESSORI / ACESSORIOS / ЗАПАСНЫЕ ЧАСТИ

COD EUR.	(Cu)	(Fe)	COD USA	(Cu)	(Fe)
64460	10-12mm	1/8"	64470	1/4"	1/8"
64461	14-15mm	1/4"	64471	3/8"	1/4"
64462	16-18mm	3/8"	64472	1/2"	3/8"
64463	22mm	1/2"	64473	3/4"	1/2"
64464	28mm	3/4"	64474	1"	3/4"
64465	35mm	1"	64475	1.1/4"	1"
64466	42mm	1.1/4"	64476	1.1/2"	1.1/4"
64467	-	1.1/2"	64477	-	1.1/2"
64468	54mm	-	64478	2"	-
64469	60mm	2	64479	-	2



CONEXIÓN ALARGADERA / EXTENSION ADAPTOR / ADAPTATEUR DE PROLONGATEUR /
VERLÄNGERUNGSVERBINDUNG / ADATTATORE PER ESTENSIONE / CONEÇÃO PARA EXTENSÃO /
УДЛИНЯЮЩАЯ НАСАДКА

COD	gr.	
64480	30	1



ALARGADERA / EXTENSION / RALLONGE / VERLÄNGERUNG / PROLUNGA / EXTENSÃO / УДЛИНИТЕЛЬ



COD	gr.	
64481	30	1



**MÁQUINAS PARA TUBO / PIPING MACHINES / MACHINES POUR TUBE
ROHRBEARBEITUNGSMASCHINEN / MACCHINE PER TUBI / MÁQUINAS
PARA TUBO / МАШИНЫ ДЛЯ ОБРАБОТКИ ТРУБ**





**CONGELADOR ELÉCTRICO PARA TUBO / ELECTRIC PIPE FREEZER / CONGÉLATEUR
ELECTRIQUE À TUBES / ROHR-EINFRIERGERÄT, ELEKTREISCH / CONGELATUBI ELETTRICO /
CONGELADOR ELÉTRICO DA TUBULAÇÃO / ЭЛЕКТРОЗАМОРОЗКА**

FREEZEMATIC

Ø		t.	Ø		t.
1/8"	(Fe)	3min	3/4"	(Fe)	14,5min
10-12mm	(Cu)	3,5min	28mm	(Cu)	17min
1/4"	(Fe)	4min	1"	(Fe)	18min
14-15mm	(Cu)	5,5min		(Cu)	20min
3/8"	(Fe)	6min	1.1/4"	(Fe)	31min
16-18mm	(Cu)	7min		(Cu)	33min
1/2"	(Fe)	9min			
22mm	(Cu)	11min			



**EQUIPO STANDARD / STANDARD EQUIPMENT / EQUIPEMENT STANDARD / STANDARDZUBEHÖR /
EQUIPAGGIAMENTO STANDARD / EQUIPAMENTO STANDARD / СТАНДАРТНЫЙ КОМПЛЕКТ**

COD	V	CAP (Cu) 	CAP (Fe) 	Kg. 	
60277	230	10-42mm	1/8"-1.1/4"	23	1
60278	110				

ACCESORIOS / ACCESSORIES / ACCESSOIRES / ZUBEHÖR / ACCESSORI / ACESSORIOS / ЗАПАСНЫЕ ЧАСТИ

COD	CAP (Fe) 	gr. 	
64482	1.1/2"	800	1
64483	2"		

